

THE BROADCAST ENGINEERS' JOURNAL

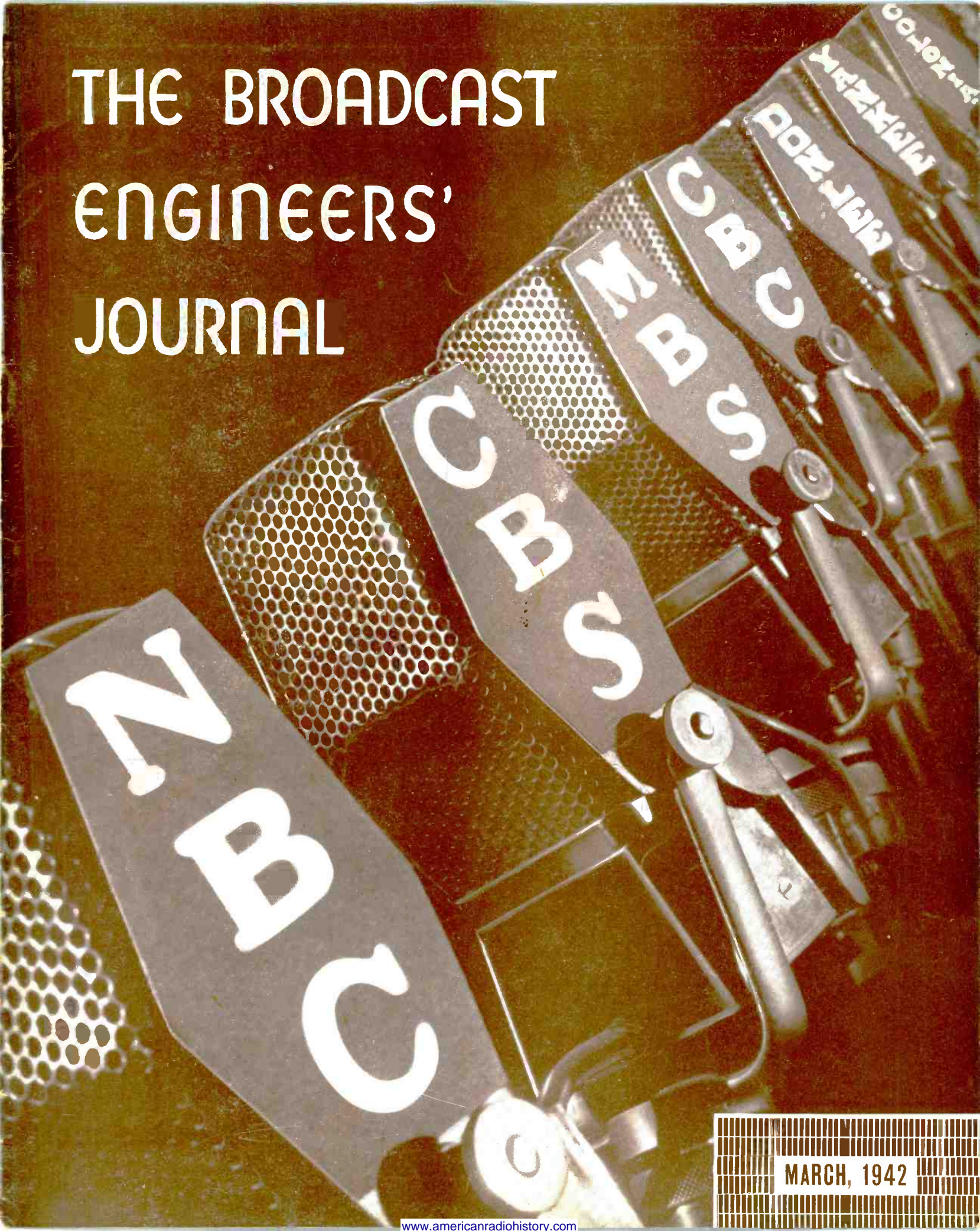

MARCH, 1942



You can write this ad . . .

Set down, if you will, all the qualities you would like in an instantaneous recording blank . . . Make no compromise with quality . . . We have an idea that you will find these exact things in the new

**ADVANCE GLASS BASE
INSTANTANEOUS RECORDING DISCS**

STillwell 4-7837

ADVANCE RECORDING PRODUCTS CO.
36-12 34th STREET LONG ISLAND CITY, N. Y.

THE BROADCAST ENGINEERS' JOURNAL

Volume 9, No. 3



March, 1942

TABLE OF CONTENTS

	Page
Engineering Executives	2
G. O. Milne	
F. A. Wankel	
Recording and Reproducing Standards	3
Diathermy and Espionage	5
Transmission Line Coupling System	6
Behind the Mike	8
Hollywood News	10
San Francisco News	12
Technical Press Review	14
Cleveland News	19
Our Own Quiz Program	20

THE BROADCAST ENGINEERS' JOURNAL

E. Stolzenberger TRUSTEES G. M. Sellar
 F. R. Rojas G. E. Stewart V. J. Duke

Managing Editor..... E. STOLZENBERGER
 Coordinator..... F. R. ROJAS
 Press Photographer..... JOE CONN
 Staff Cartoonists..... ED. MACCORNACK, ROSS PLAISTED
 Circulation Manager..... TED KRUSE
 Subscription Manager..... ARTHUR G. POPPEL
 Features..... TOM GOOTEE
 Treasurer..... C. W. PHELAN
 Assistant Treasurer..... D. J. MOLONEY

ASSOCIATE EDITORS

Chicago..... CON CONRAD
 Cleveland..... J. D. DISBROW
 Denver..... J. ROHRER
 Engineering Chapter..... BOB FRASER
 Hollywood..... RAY FERGUSON
 KFI-KECA..... H. M. McDONALD
 Mutual Broadcasting..... R. A. SCHLEGEL
 New York..... D. C. SHULTIS
 San Francisco..... F. L. BARRON
 Washington..... BILL CHEW

The Broadcast Engineers' Journal is a privately printed monthly publication, issued by A.T.E. Publications, Inc., a corporation of the State of New Jersey. Address all communications to Editor's office: E. Stolzenberger, 116-03 91st Avenue, Richmond Hill, L. I., N. Y. Telephone Virginia 9-5553. **THE BROADCAST ENGINEERS' JOURNAL IS THE OFFICIAL PUBLICATION OF THE N.A.B.E.T.**

Advertising rates and information supplied on request. Subscription, \$1.50 per year; \$3.00 for three years. Single copies, except Christmas Yearbook, 25c; Christmas Yearbook, 75c, subject to availability. All remittances in advance. Foreign: Add postage.

Nothing appearing in The Broadcast Engineers' Journal shall be construed to be an expression of The Broadcast Engineers' Journal or the National Association of Broadcast Engineers and Technicians, but must be construed as an individual expression of the author or authors.



We can't give you immediate delivery of Scully Master Recorders, nor can we guarantee you a future delivery date---Because our first effort now is to win the war!



We suggest that when recording equipment is required in connection with morale programs or some other phase of the war effort, that you obtain a priority rating — then send us the order promptly.

Prompt Action NOW will assure you of future delivery

Provide for

Scully Master Recorders

in your next budget and Order NOW

SCULLY Machine Company

62 Walter Street

Bridgeport, Conn.

Telephone Bridgeport 5300

F. A. Wankel

**Veteran Engineer Becomes NBC Eastern
Division Engineer**

Born in Brooklyn, N. Y., on January 30, 1905, Wankel first became interested in radio during World War I when bedsprings were standard antenna and crystal detectors were the "last word." Building radio sets for neighbors was a hobby through his High School days, and during this period his first "ham" transmitter, 2AMX, came into existence.



F. A. Wankel

He graduated from the Polytechnic Institute of Brooklyn in 1927 with the degree of Electrical Engineer. During his four years at the Institute he was President of the Student Council, President of the Student Branch of the A. I. E. E., and President of the local Chapter Theta Kappa Nu Fraternity. During summer vacations he worked for the Brooklyn Edison Company on an industrial survey, and in the high voltage laboratories of Westinghouse at East Trafford, Pa.

After graduation he worked as assistant test engineer with the Brooklyn Union Gas Company. He was employed by the National Broadcasting Company on October 1, 1928, as one of the first Student Engineers, which included work at the radio transmitter, and in the maintenance, field, studio and laboratory groups. He was then assigned to studio operation and became Transmission Engineer in 1930. In the planning of equipment layout for Radio City it was deemed advisable to have a man in the group familiar with operating practice. Wankel was temporarily loaned to the Audio Facilities Group for this purpose in 1933. Several of the present features of the Master Control Room were his contribution.

During this assignment the technical members of the Engineering Department formed an Association of Technical Employees, later known as ATE. Wankel was selected by the men as the New York representative, and at a National Convention held in New York was elected the first President of the Association. He again returned to the operating group as Transmission Engineer in 1934.

When NBC decided to install the all-electronic RCA Television System in its New York office, Wankel was transferred to the Development Group and accompanied Mr. R. E. Shelby, present Development Engineer, to the RCA Manufacturing Company at Camden. There they studied the laboratory set-up and made changes in the design adapting it to NBC operating requirements. The results of their pioneering work in electronic television were first demonstrated in the NBC-RCA field test started in July, 1936. Wankel continued in the various operating phases of television and was made Senior Television Supervisor in 1940.

(Continued on Page Eight)

G. O. Milne

**Heads BLUE NETWORK Engineering as
Chief Engineer**

In point of service and experience, George Milne, Chief Engineer of the BLUE Network Company, is not only a veteran but a pioneer of the radio industry.

Born in Mamaroneck, N. Y., on September 21, 1902, Milne was bewitched by a "crystal set" back in his grammar school days and by the time he reached the higher schools of learning he was organizing dramatic and radio clubs among fellow students.

Following graduation he became fascinated by a recruiting poster, and decided to "see the world" as a licensed commercial radio operator. Parental objection, however, kept him ashore. Thus he entered the employ of the Public Service Electric Co.

A year later, Milne enrolled at the Western Electric Installation School for a general three months' course. From a group of approximately 200 other enrollees he was one of two men chosen for further training and after a year was sent into the field as a boss.

Active in amateur radio on the side, Milne watched radio develop as a commercial possibility. A short time after commercial broadcasting was inaugurated he applied for and received a transfer to the Broadcasting Department of the American Telephone and Telegraph Company, beginning his career with station WEAJ in 1923.

For four years Milne alternated from maintenance man to studio control man, telegraph operator, field engineer and transmitter operator, thoroughly familiarizing himself with each aspect of operations. In November, 1927, he was made control supervisor. The following July he was advanced again to operations supervisor.

As the networks expanded, Milne also served in an advisory capacity for affiliated stations and in January, 1930, was named Division Engineer when that office was created in New York.

When the BLUE Network Company was organized as an independent, competing network, Milne was the logical man to direct its technical operations. He was named Chief Engineer with broad authority and greater responsibility.

Politically and socially-minded, Milne has lived for the past fifteen years in Wood Ridge, N. J., where he served a three year term as Town Councilman. Previously a staunch Republican, he became the second Democrat elected in the town in more than forty years — a tribute to his personality and civic virtue.

A member of the Institute of Radio Engineers, Milne's hobbies are stamp collecting and bowling. He is a former

(Continued on Page Eight)



G. O. Milne

Recording and Reproducing Standards

As recommended by the Recording and Reproducing Standards Committee of the National Association of Broadcasters

(From a paper delivered by Howard A. Chinn, Columbia Broadcasting System, at the Fifth Annual Broadcast Engineering Conference at Columbus, Ohio, February 26, 1942)

AS BROADCASTING has developed, the problem of reproducing transcriptions with uniform results has become of much concern to broadcasting stations. Quite a number of different characteristics have been used by the various manufacturers of transcriptions, recording equipment and reproducing equipment. Most of these characteristics produce good results by themselves with the proper playback equalization. The NAB Engineering Committee early last year sent a questionnaire on recording to all stations. Among other interesting data obtained was the fact that some stations use as high as ten different equalizers. The NAB Engineering Committee recommended to its Board of Directors that NAB coordinate the work of a Committee to be formed for the purpose of establishing recording and reproducing standards. The Board of Directors approved of this procedure and early in June, 1940, Neville Miller, President of the NAB, invited all companies interested in recording to a meeting to be held on June 26, 1941, in Detroit. Some twenty companies responded by sending representatives to the meeting. The Recording and Reproducing Standards Committee was formed at that time. The Committee drew up a set of rules and regulations for conduct of the work. The Committee also at that time formulated a list of the items that should be considered for standardization. In order to supervise and expedite the work, an Executive Committee of five members was appointed.

The Executive Committee was instructed to recommend standards on items that require little or no special study. It also was instructed to recommend a line of procedure for standardization on all other items.

The Executive Committee reported to the main Committee at a meeting held in New York City on October 23, 1941. The main Committee with minor changes adopted as standards or recommended good engineering practice sixteen of the items proposed by the Executive Committee. The Committee decided to divide the remaining items be-

tween four Subcommittees for further study. The several committees have made good progress to date. However, the war effort has seriously curtailed the speed of the work and it is not expected that enough additional work will be finished for two or three months more so as to warrant another meeting of the main Committee. The Committee felt that application of the sixteen standards already adopted should not be delayed and they are therefore being submitted to the industry at this time. Although NAB has not as yet officially placed its stamp of approval on these standards, it is believed that this is merely a formality and there is no reason why the industry cannot proceed with the use of the standards already adopted.

Following are the sixteen standards as already adopted by the RRSC. (The main Committee consists of 77 members and is representative of those interested in recording.—Ed.)

Technical Standards and Good Engineering Practices of the National Association of Broadcasters for Electrical Transcriptions and Recordings for Radio Broadcasting:

1. OUTER DIAMETERS. It shall be standard that the outer record diameter fall within the limits specified in the following table:

Nominal	Finished Records Pressings or Instantaneous	Lacquer Originals For Process
16"	15 ¹⁵ / ₁₆ " ± ³ / ₃₂ "	17 ⁷ / ₈ " ± ¹ / ₁₆ "
12"	11 ¹ / ₈ " ± ¹ / ₃₂ "	13 ³ / ₄ " ± ¹ / ₁₆ "
10"	9 ⁷ / ₈ " ± ¹ / ₃₂ "	11 ¹ / ₄ " min.

2. CENTER HOLE DIAMETER. It shall be standard that the record center hole diameter be 0.286 inches ± 0.001 inches.

3. TURNTABLE CENTER PIN DIAMETER. It shall be standard that the diameter of the center pin of a transcription turntable be 0.2835 inches ± 0.0005 inches.

4. OUTERMOST GROOVE DIAMETER. It shall be standard that the diameter of the outermost groove be within the limits specified in the following table:

16" Outside Start	15 ¹ / ₂ " ± 1/16"
16" Inside Start	15 ⁹ / ₁₆ " maxim.
12" Outside Start	11 ¹ / ₂ " ± 0.020"
10" Outside Start	9 ¹ / ₂ " ± 0.020"

5. INNERMOST GROOVE DIAMETER. It shall be standard that the diameter of the innermost groove shall not be less than 7¹/₂" in the case of 33 ¹/₃ rpm records, and not less than 3³/₄" in the case of 78 rpm records.

6. UNIFORMITY OF GROOVE SPACING. It shall be standard that the recorded grooves on a record shall be so spaced that at no point (except the concentric stopping groove) does the pitch deviate from the mean groove pitch by more than 5%.

7. STOPPING GROOVE. It shall be standard that at the termination of the recording groove spiral a locked concentric stopping groove shall be provided.

8. NUMBER OF BLANK GROOVES. It shall be standard that the number of blank grooves, before modulation occurs, shall be not less than two complete revolutions nor more than four, exclusive of any starting spiral.

9. RECORDING TURNTABLE SPEED (rpm). It shall be standard that the mean speed of the recording turntable be either 33 ¹/₃ or 78.26 rpm ± 0.5%.

10. WOW FACTOR. It shall be standard that the maximum instantaneous deviation from the mean speed of the recording turntable, when making the recording, shall not exceed ± 0.1% of the mean speed.

11. RECORD WARP. It shall be standard that the maximum departure of the surface of a record from a true plane because of warping shall not be in excess of 1/16".

12. MINIMUM LABEL INFORMATION. It shall be standard for the

(Continued on Page Five)

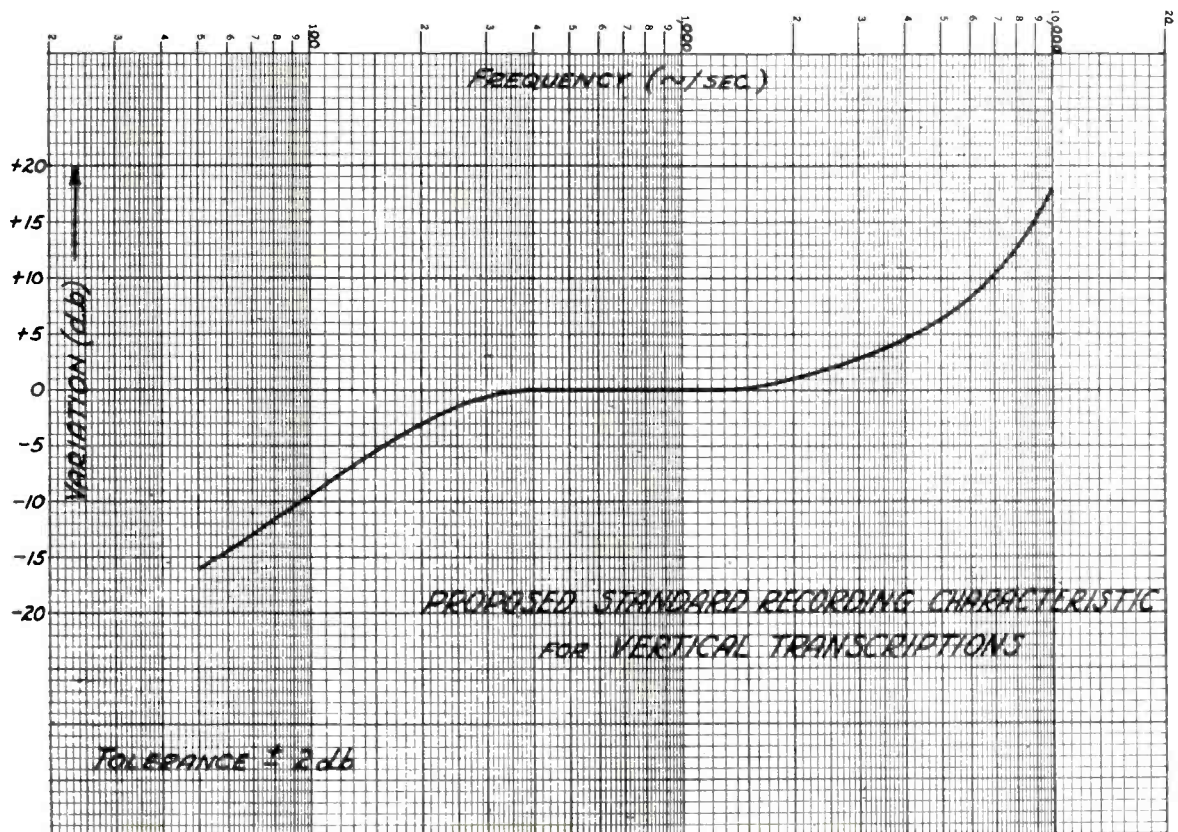
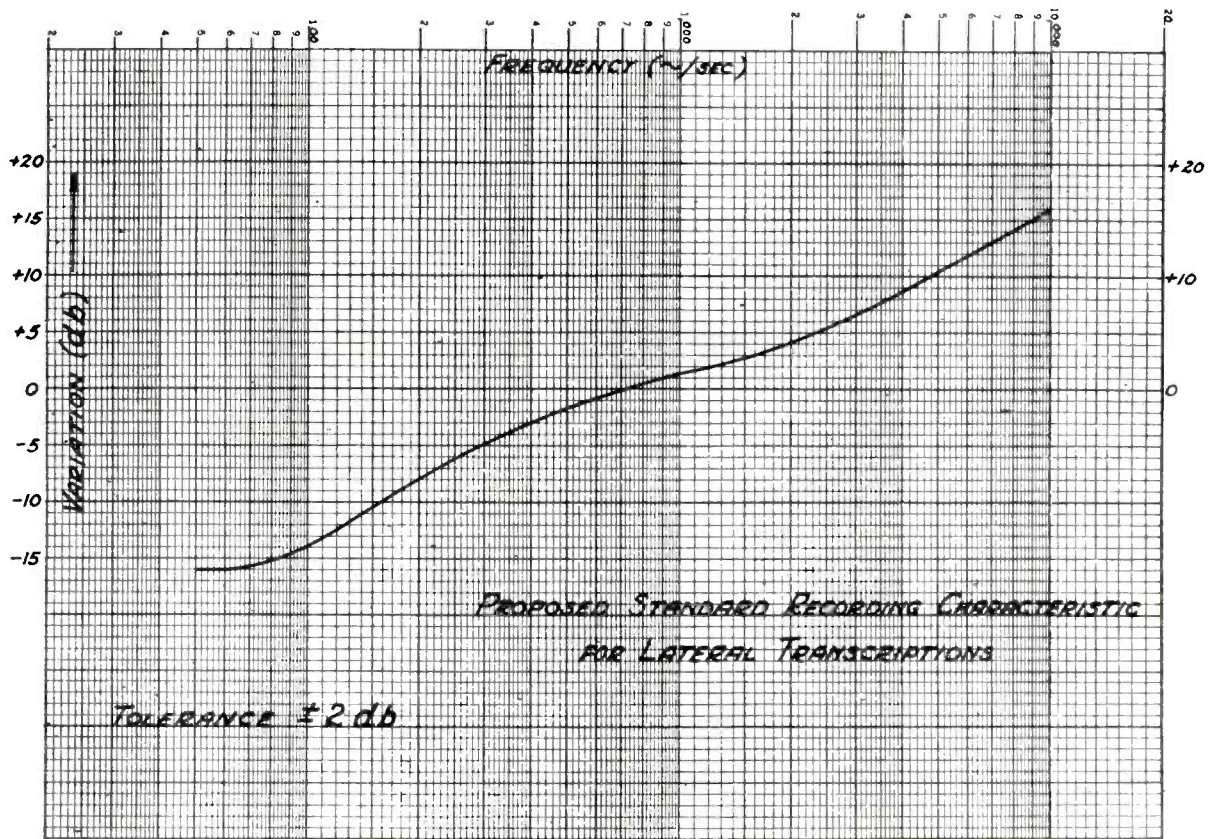

Recording Standards

(Continued from Page Three)

label of a recording to contain at least the following technical information:

- a. type of recording—vertical or lateral.
- b. speed—78.26 or 33 1/3.
- c. direction of feed (start)—outside in, or inside out.
- d. recording frequency characteristic.

13. FREQUENCY CHARACTERISTIC FOR VERTICAL RECORDING. It shall be standard that the recorded frequency characteristic on vertically recorded records be as shown herewith.

14. FREQUENCY CHARACTERISTIC FOR LATERAL RECORDING. It shall be standard that the recorded frequency characteristic on laterally recorded records be as shown herewith.

15. STARTING SPIRAL GROOVES PER INCH. It shall be good engineering practice in recordings having a starting spiral to use a rate of 8 grooves per inch for the spiral (tolerance ± 2 grooves per inch).

16. RECORDING GROOVES PER INCH. It shall be good engineering practice to use numbers of grooves per inch in recording as follows: 96, 104, 112, 120, 128, 136, etc., in increments of 8 (tolerance ± 2 grooves per inch).

Diathermy and Espionage

IT IS ironic that a medical instrument originally designed to relieve the pain of human suffering and greatly advanced and improved by the United States, should now be used by Axis agents to attempt to bring about the destruction of this country.

But such a condition now exists within the Continental United States! And there is something you can do about it!

Diathermy "artificial fever" machines—long a source of minor radio interference—have now been discovered by the FBI and the FCC in still another capacity: a means of illegal radio communications. Many instances of such use of this medical instrument for transmitting information to Berlin and Tokio have been detected on both the east and west coast. Under the pretense of being used for medical purposes, the spy operators have found a compact, highly-portable radio transmitter for their subversive use.

With only minor changes, these

(Continued on Page Sixteen)

The Broadcast Engineers' **5**
Journal for March, 1942

TWO VALUABLE NEW FEATURES HAVE BEEN ADDED TO THIS PRESTO RECORDER!



Here is a more versatile recording turntable, a recorder with variable cutting pitch, one that can be quickly adjusted for discs of varying thickness, a machine that will operate "faster" in busy control rooms. It's the new Presto 8-C recorder with . . .

INDEPENDENT OVERHEAD CUTTING MECHANISM: The cutting mechanism of the 8-C is rigidly supported at one end by a heavy mounting post $2\frac{1}{4}$ " in diameter. The other end is free of the table so that the alignment is independent of the disc thickness. A thumbscrew above the cutting head carriage adjusts the angle of the cutting needle *while cutting* for any direct playback or master disc from .030" to $\frac{1}{4}$ " in thickness. The cutting mechanism swings clear of the table for quick change of discs.

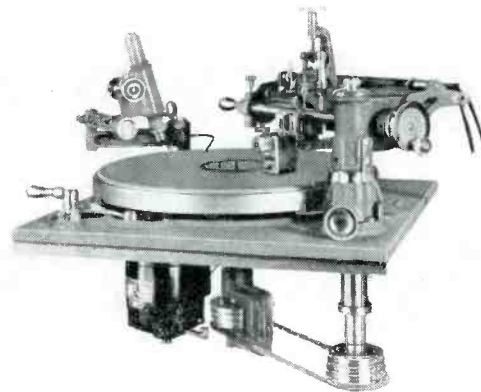

VARIABLE CUTTING PITCH: The buttress thread feed screw is driven by a belt and two step pulleys beneath the table giving accurate cutting pitch adjustments of 96, 112, 120, 128 or 136 lines an inch. Changing the cutting pitch is a matter of seconds. A hand crank and ratchet on the feed screw spirals starting and runout grooves up to $\frac{1}{4}$ " apart.

Other specifications are identical with the well-known Presto 8-N recording turntable described in our complete catalog. Copy on request. Cabinets are available for mounting single or dual turntable installations. If you are planning to improve your recording facilities write today for price quotations and detailed specifications.

PRESTO
RECORDING CORP.
242 WEST 55th ST. N.Y.

In Other Cities, Phone . . . ATLANTA, Jack. 4372 • BOSTON, Bel. 4510
CHICAGO, Mar. 4240 • CLEVELAND, Me. 1565 • DALLAS, 37093 • DENVER,
Ch. 4277 • DETROIT, Univ. 1-0180 • HOLLYWOOD, Hil. 9133 • KANSAS
CITY, Vic. 4631 • MINNEAPOLIS, Atlantic 4216 • MONTREAL, Wel. 4218
PHILADELPHIA, Penny. 0542 • ROCHESTER, Col. 5548 • SAN FRANCISCO,
Yo. 0231 • SEATTLE, Sen. 2560 • WASHINGTON, D.C., Shep. 4003

World's Largest Manufacturers of Instantaneous Sound Recording Equipment and Discs

A Transmission Line Coupling System

By R. W. Clark

NBC Engineering Department, Development Group

THIS paper presents a solution to a radio receiving problem, whereby, with a number of receivers and a number of antennas and transmission lines, any receiver or group of receivers may be connected to any transmission line with no disturbance in the unswitched receivers and no impedance mismatch.

With one or two receivers, and one or two transmission lines, the problem can be solved a number of ways without much difficulty; but as the number of lines and receivers increases, the switching problem is more complicated. Also, if all receivers are connected to one transmission line, the impedance mismatch may reduce the signals to an unusable level. The coupling difficulties also increase with the band-width of frequencies it is desired to cover.

3. Five receivers, each of 500 ohms input impedance.

4. Frequency band, 5,000 kc to 20,000 kc for each antenna and transmission line.

Of the several methods for accomplishing the desired result, the ones leading to the present solution are discussed.

The use of a cathode follower tube connected to the line and feeding the receivers is not feasible from the gain standpoint. The impedance of several receivers in parallel will be of such a low value that there will be considerable loss in signal level through the tube. The use of one cathode follower for each receiver was considered. While this will have more gain than the former method, it has a serious disadvantage. The input capacity of a tube, with wiring, will be about 20 mmf. Thus the shunt capacity

This leads to consideration of the following system: If a number of filter sections are connected in series, the total shunt capacity may be divided into

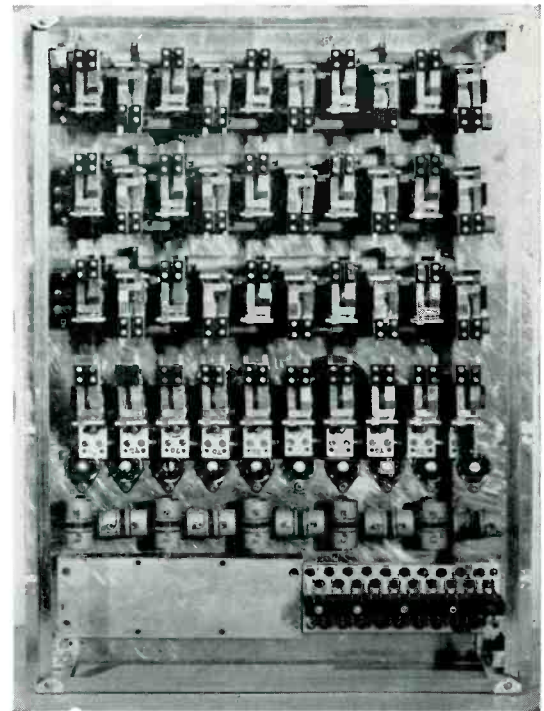

Fig. 4

smaller parts by the number of sections. For example, if as above, there are seven tubes of 20 mmf each, then if seven filter sections are used, the shunt capacity of each section may be the capacity of one tube. The filter section known as the Bridge-T is readily adaptable for this circuit, and with proper design, the voltage across the shunt capacitor equals the input voltage to the filter. If the shunt capacity of each section is a tube input capacity, the voltage on the tube grids will equal the voltage applied to the filter input. This may be better illustrated by referring to Fig. 1. The signal energy is applied to the input of the filter section L10, and this voltage will be the same as that across the shunt capacities of section 1A and of section X. The coils are so designed that the loss through several sections is negligible, so

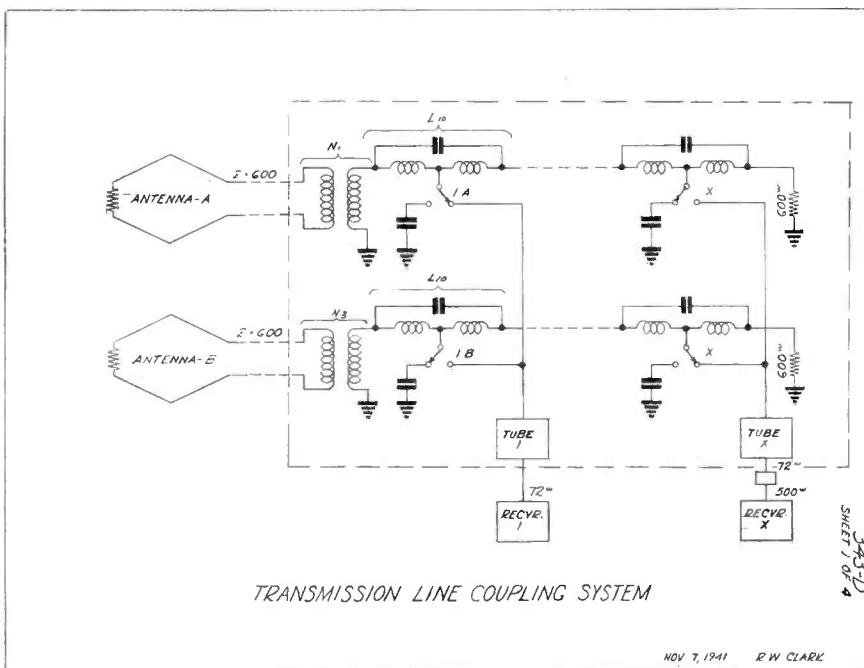

Fig. 1

As an example, consider the following hypothetical case:—

1. Two antennas and transmission lines, the latter of 600 ohms impedance.
2. Two receivers, each of 100 ohms input impedance.

for seven tubes will be 140 mmf, which has an impedance of 60 ohms at 20,000 kc. For a 600 ohm line, this shunt impedance would cause considerable impedance mismatch with consequent loss of gain.

the voltage on the last section equals the voltage on the first section. Switching a tube to or from a filter section simply means a change of capacitors for that particular filter section, but no change in the value of the shunt capacity, so the system is not disturbed.

This sketch, Figure 1, shows a coupling network (N_1) from a balanced line to an unbalanced circuit. This gives full line voltage across the filter. This network may be designed for the 5,000 kc to 20,000 kc band, but its construction is quite difficult. A network covering a narrower band can be constructed, and further discussion of this is taken up later.

In order to accommodate the wide frequency band, the system shown in Fig. 2 was developed. As shown, the transmission line feeds the filter sections direct, filter sections being placed in both sides of the line. Coupling to the tubes and switching remains the same.

The distribution of the signal energy to the receivers is best accomplished with a low impedance line, the 72 ohm coaxial cable being a practical solution. If the coupling tubes fed the 72 ohm circuit directly, there would be an undesirable voltage loss, so a coupling transformer is used. From the tube side of the impedance is 500 ohms, so by using a 6AC7 (1852) tube, a voltage gain of four is obtainable. The output of this network is 72 ohms, and feeds the coaxial line connected to the associated receiver. If the receiver has a nominal input impedance of 100 ohms, it may be connected directly across the coaxial line. For receivers of 500 ohm input impedance, another 500 to 72 ohm network is connected between the coaxial line and the receiver, the 500 ohm side being connected to the receiver. In Fig. 2, each tube has a 500-72 ohm coil, receivers 1 and 2 have 100 ohm inputs. Receivers 3, 4 and 5 have 500 ohms inputs, the added networks being shown. This method of feeding the receivers allows a physical re-arrangement of them to be made easily at any time.

This wide band system using a 6AC7

(Continued on Page Nine)

POPULARLY PRICED

For General Laboratory Use And Production Testing



● Rugged, precise, reliable . . .
input and output impedances
independently adjustable.

● Ideally suited to F.M.—
Studio and other wide range
sound system measurements.



ATTENUATION NETWORKS

SERIES 690 AND 692

for Transmission-Efficiency, Power-Level Measurements, Impedance Adjustments, Gain or Loss Measurements on Amplifiers, Filters, Pads

The Series 690 network consists of plug-in input and output adjusting networks, and a Units and Tens attenuation controls.

The Series 692 network is essentially the same as the 690 with the exception that a Tenths, a Units and a Tens attenuation controls are provided. Both types, 690 and 692, are offered in either "T" or "Balanced H" networks.

The attenuation controls are constant impedance, zero insertion loss networks each having 10 steps of attenuation. The Daven Series 6900 Impedance Matching Networks ("plug-in" units) may be obtained in a wide range of impedance and loss.

TYPE	Z	RANGE	CIRCUIT	PRICE
T-690-A	500	0-110 Db. in step of 1 Db.	"T" Network	\$60
H-690-B	500	0-110 Db. in step of 1 Db.	Balanced "H" Network	80
T-690-C	600	0-110 Db. in step of 1 Db.	"T" Network	60
H-690-D	600	0-110 Db. in step of 1 Db.	Balanced "H" Network	80
T-692	500	0-111 Db. in steps of 0.1 Db.	"T" Network	80
H-692	500	0-111 Db. in steps of 0.1 Db.	Balanced "H" Network	100
T-693	600	0-111 Db. in steps of 0.1 Db.	"T" Network	80
H-693	600	0-111 Db. in steps of 0.1 Db.	Balanced "H" Network	100

Supplied complete with one set of 6900 networks. Unless otherwise specified, these will be 500 ohms, or 600 ohms, zero loss networks. Base impedances other than 500 ohms or 600 ohms available upon request.

THE DAVEN COMPANY

158 SUMMIT STREET • NEWARK, NEW JERSEY

Behind the Mike

By Con Conrad

J. ALUSIC, NBC Chicago Studio Engineer, now transferred to the Blue Network, Inc. Joe is the first engineer of the Blue to be a proud pappy, with the arrival of a son born in late February.

Women to the front again in the Engineering Field. MAJORIE ALLEN, formerly Instructress of Radio Communication for Woman Volunteer Services, has joined the FM Unit W 47 NY in New York doing double duty as Engineer and Announcers.

FRANK HIGGINS has volunteered for duty with the Naval Reserves. Frank is Transmitter Operator with WPTF, Raleigh, N. C.

RAY BIERMAN, NBC Engineer, Chicago, Illinois. Ray, Operator on Vic and Sade and numerous other daytime Soap Operas, has been transferred to the Blue Network, Inc., Chicago.

HAROLD J. MARSH, formerly of WSPD, Toledo, has been called back to active duty with the Army Signal Corps. Harold has the rank of Sgt.

More to the Army, etc. EVERETT STURDY has resigned his job at KFVD, Los Angeles, and leaves his Engineering duties to join the Army Communications Division in a Civilian capacity.

ERNEST PETERSON of WTIC's Transcription Library is the third member of the station's staff to enter the Armed forces. Ernie enlisted in the U. S. Army Air Corps, and at present is stationed at Jefferson Barracks, Mo.

W. H. CUMMINGS, Field Engineer NBC, Chicago, formerly of Dodge Institute, has been transferred to duties with the Blue Network, Inc.

ELY I. BERGMANN, formerly on the Special Events Division of the Municipal Broadcasting System of the City of New York, is now employed at the WOR transmitter plant at Carteret, N. J.

DAVID BAIN, Chief Engineer with WBML, Macon, Ga., has resigned and now becomes associated with the Bureau of Ships, Navy Department in Washington, D. C., as Engineer.

A. L. HOCKIN, Studio and Recording Engineer with NBC, Chicago, and formerly Airline Operator, has been transferred to the Blue Network, Inc., Chicago.

FREDDY EDWARDS, S.E., and amateur operator of W1DJC, joined the ranks of the benedicts on February 21. The girl is the attractive Ruth Dixon of the Travelers Ins. Co. Edwards, a veteran WTIC staff member, and his bride will live in a new home now under construction in Manchester, Conn.

G. F. KEMP, NBC Chicago Studio Engineer and one of the early morning ops., formerly with the Airlines, has been transferred to the Blue Network, Inc.

GENE TWOMBLEY, CBS, Hollywood, Calif., is Number Six of the Networks' Staff in that city to join the Armed Forces.

Engineers of Hartford's Radio Stations, WTIC, WNBC, WDRC and WTHT, have all put their heads together in an effort to aid the National Defense Program. The boys are teaching the fundamentals of radio to many men and women to augment the supply of radio men for National Defense purposes. Classes are held two nights each week and will require 20 weeks.

W. T. KNIGHT, NBC Chicago Studio Engineer and a Dr. of Optometry, has been transferred to duties with the Blue Network, Inc., Chicago.

E. C. HORSTMAN, President of NABET, Control Room Supervisor NBC Chicago, has been assigned more responsible duties with the Blue Network, Inc., Chicago; with the new duties, Ed has resigned as President of NABET.

More to the Army: CHARLES HARTMAN, WCAU, Philadelphia, Pa., Engineer, has joined the Armed Forces.

E. A. MAC CORNACK, NBC Chicago Studio Engineer, and NABET Journal Cartoonist and Engineer on many of the leading night shows, has been assigned new duties in the Engineering Department of the Blue Network, Inc., Chicago.

ALLAN GUNDERSON, Assistant Chief Engineer KDYL, Salt Lake City, Utah, is now on active duty with the U. S. Naval Reserve.

H. L. REYNOLDS, Quiz Kids Engineer at NBC Chicago, is another of the boys wearing the new BLUE BUTTONS; his duties with the Blue Network, Inc., became effective with the first day of February.

MICHAEL CHUCKRAY, Engineer of KXOK, St. Louis, Mo., has enlisted with the Navy and by now is on duty at the Naval Radio Training School.

M. F. ROYSTON, NBC Chicago Studio Engineer and Recording Specialist, has been transferred to the Blue Network, Inc.

L. L. WASHBURN, Studio Engineer with NBC Chicago, has been called to active duty. "Wash" is a First Lieutenant with the Signal Corps, and when last heard from was stationed in Washington, D. C.

F. C. SCHNEPPER, NBC Chicago Field Engineer, and B. H. SPIERS, Studio Engineer with NBC Chicago, have both been transferred to the Blue Network, Inc., Chicago.

Work on W 53 H's new transmitting tower was set back the other day when a pulley gave way causing part of the construction to collapse. Two men were slightly hurt by swinging steel. Plant Chief HERMAN TAYLOR estimates the mishap will cause several weeks delay in completing the tower.

F. A. WANKEL

(Continued from Page Two)

The last promotion to Eastern Division Engineer in January, 1942, was made after six and a half years in audio and six and a half years in video, as Wankel calls it "a balanced diet."

Wankel married Mildred Neuberth in 1929 and has a seven-year-old daughter, Gayle.

G. O. MILNE

(Continued from Page Two)

president of the NBC Stamp Club. Another hobby—now abandoned in accordance with war-time regulations—was a powerful "ham" radio set, station W2ZA. Prior to the war he used to chat almost nightly with fellow "hams" in such remote spots as the North and South Poles and Tibet. He has a collection of acknowledgment cards from 135 countries.

Milne is married and has two sons, nine and twelve.

Transmission Line Coupling

(Continued from Page Seven)

(1852) tube has a power gain of 2. This can be shown as follows:—

Let \mathcal{E} equal voltage on the balanced transmission line

R equal the terminating resistance or 600 ohms.

$R/8$ equal the receiver circuit resistance. ($600/8=75$)

$\mathcal{E}/2$ equal the voltage on tube grid; due to gain in tube the signal voltage on the 72 ohm circuit equals the grid signal voltage.

So—power in transmission line equals \mathcal{E}^2/R , and power in receiver feed line equals

$$\frac{\mathcal{E}^2/2}{R/8} = 2\mathcal{E}^2/R$$

With regard to the network N_1 in Fig. 1, two designs were provided, one design (N_1) for the frequency band from 5,000 kc to 13,000 kc, the other design (N_3) for the band from 12,000 kc to 21,000 kc. For either coil the filter sections (L_{10}) remain the same. Provided there is no necessity of receiving frequencies in the two bands simultaneously, on the same antenna, this method

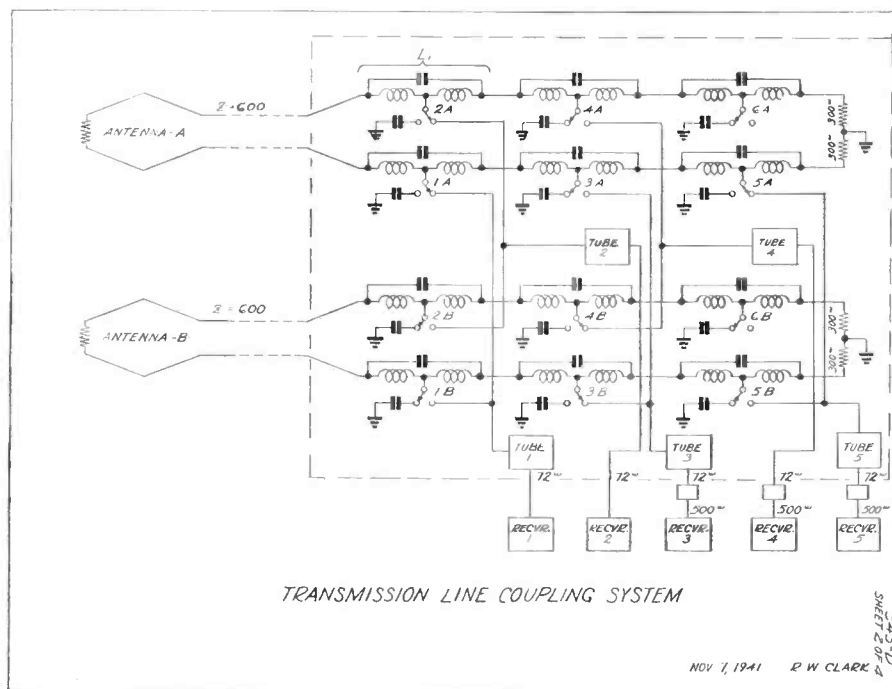

Fig. 2

will give 6 db more gain than the wide band system, but means of switching the coupling coils must be provided.

Fig. 3 shows the frequency response

curves of the described systems. The input voltages were constant for each curve, but not the same value for all

(Continued on Page Thirteen)

If you have not been using or have not yet tried Allied's New Glass Base Discs, a trial will convince you of their merits and superior quality — at no premium in the cost to you. We invite you to try this disc — that is how we obtain new customers. We feel certain that you will

reorder — that is how we build sales volume — from satisfied users. Your telephone call, letter, wire or cable will receive our prompt and courteous attention.

PROMPT DELIVERY direct from the manufacturer to any part of the United States, Canada, South America and to some foreign countries. ALSO AVAILABLE recoating service for your old aluminum discs. Delivery in one week. Details on request.

ALLIED RECORDING PRODUCTS CO.

21-09 43rd Avenue

Phone Stillwell 4-2318
Cable: Allrecord New York

Long Island City, N. Y.

ALLIED GLASS BASE RECORDING DISCS



Hollywood News

By Ray Ferguson

WE RAN across this picture the other day of Guy Cassidy of San Francisco Engineering. Not knowing we found his picture, Guy, no doubt, will be as surprised as we are delighted in bringing forth in this column his nib's likeness in black and white.

It was while reflecting on past and pleasant days at One-Eleven Sutter we used to shoot the breeze with Guy between shows late at night. On nights when San Francisco would be shrouded in fog and the hooting and wailing of boat whistles on the Bay more often than not caused our thoughts to drift back to our days of brass-pounding at sea, many were the salty tales that would come to life again. One such story, which we still remember well because for its background the

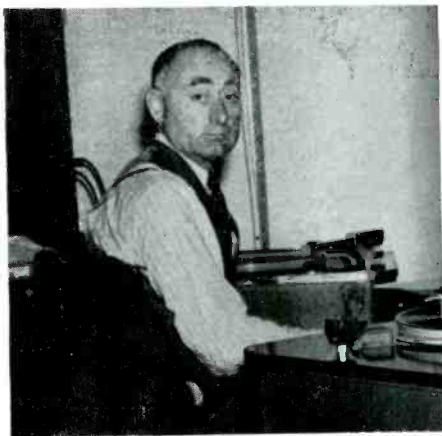

China Coast offered its colorful and romantic outline, and we were one of the participants right in the middle of it. It was when our ship, one of the old Dollar Trans-Pacific 535 type vessels was at Shanghai.

The Captain had called us to his quarters. It all comes back as clear as day now, hearing from those days gone by the Old Man asking, "You men understand the use of fire arms?" Our voyages in the past had always been uninterrupted and quite calm, except for those days in the North Pacific of heavy gales and nights filled with static. But now, with a large consignment of gold aboard for Hong Kong, it appeared as though our routine life aboard ship might hold something else in store. After replying to the Skipper's question that, as a kid on a ranch, we had smelled quite a bit of powder burned up on jack-rabbits and cayotes, he went on to say that because of the large amount of gold from Shanghai aboard there was a rumor that some of the three hundred odd in steerage might not all be just peace-loving, honest and law-abiding Chinese. In the past, the Captain went on to explain, China Coasters had been pirated between Shanghai and Hong Kong when suddenly in the dead of night the ships had been taken over by armed Coolies from the steerage. Wondering how such a thing could ever happen to such a large ship as our 535 but, at the same time recalling the various theories heard from trip to trip about not only our ship but the Empress boats as well, we left the Captain's quarters armed with a riot gun and several pistols which were distributed among the three radio men. Our ship got away from Shanghai with a farewell blast from that mighty, raucous spark-gap at FFZ, which sounded like a giant rooster crowing from 100 to 1,000 meters, and we dropped the pilot where the Woosung melts into the Yellow Sea, gave our clearance to PTG, and headed for Hong Kong. The following night on the twelve to eight a.m. watch with the China Coast roaring away merrily on 600 meters, with everything

from Dutch, British, German, Italian, American and Chinese blasting away through the static, as though FFZ could never be raised; PTG with three or more after him for bearings and VPS, Hong Kong, just beginning to come in with that smooth 600 cycle rotary of his, we had just settled back in the chair to survey matters and, at the same time, wonder why the Chinese coast stations had to call each other twenty-five times with their gritty sounding rotaries. Typical of the ships of the Line, we had a 1/2 kw. Simmons quenched-gap on our right. In front was the reliable S.E. 142 two stage receiver. On the left a 5 kw. Federal arc took up quite a bit of space at that end of the room. Beyond the big converter was one of the two port holes for the radio room. It had been covered with a large bath towel for the trip down as had been the other port directly ahead of the radio compass switch.

The night was quite warm and the sea smooth. The ship was as quiet as a sleeping village. It was three o'clock. 600 meters rocked and shook with the China Coast QRM and static. The headset rattled as XOW at Foochow opened up with a long code message and a Frenchman close by started calling VPS at Hong Kong. The ship held to its course and

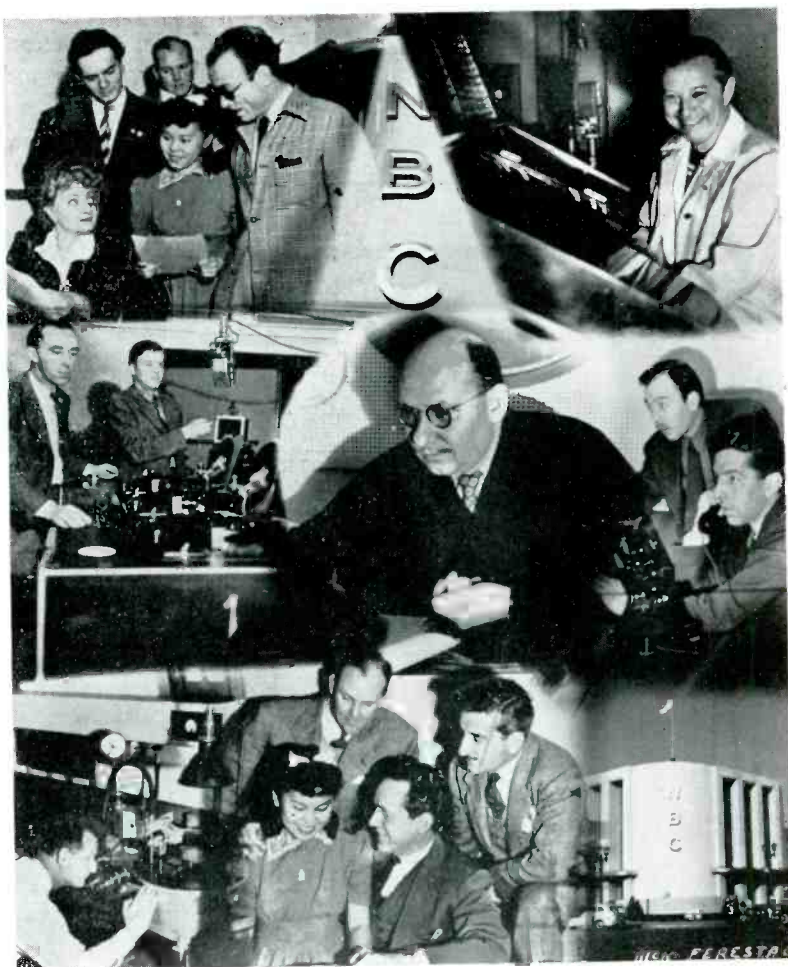

I LOVE A MYSTERY

Carlton Morse, writer and director, and his cast and technical crew. Bob Brooke, engineer.



Abbott and Costello look over Eddie's shoulder at his pair of ND-10's as Clark Sanders, San Francisco engineer, backs Eddie up with a very thoughtful gaze at the ND-10 on the starboard side.

throbbled along through the night. Suddenly, something seemed to be moving aside the towel which covered the porthole over by the big arc transmitter. The effect was startling! The big .44 cal. pistol, hung under the equipment desk, felt like a coast defense gun. Mental visions sprang up of that baby kicking enough to break an arm, not daring to turn and look straight at the towel for fear of seeing something there that would only scare the daylights out of us more than ever! The thought, "It's a rifle barrel somebody is trying to sneak past the towel and draw a bead to shoot!" came and then, with hair standing on end, a forced look showed just the same old towel covering the same old port hole and nothing else. More frightening thoughts, "Maybe there are pirates on the bridge; in the engine room, all over the ship by now!" And then that movement of the towel seemed to again be that of an object being quietly slid around its edge. Hardly daring to move, to even turn in that direction and too scared to take a deep breath, a few shaky steps brought us over just to one side of the porthole. There was no rifle barrel. Cautiously, we looked out and down on the boat deck expecting within a second to get konked over the head and thinking what a foolish thing to be sticking the old chin out like that was. Still nothing happened. A breeze had come up. Returning to the chair in front of the receiver and, with heart thumping madly, we finally sat down again and heaved a great sigh of relief. That tricky little breeze was the cause of it all, making the towel move like it had in front of the porthole.

Well . . . at three o'clock in the morning and everything so utterly quiet, with just enough light from the desk lamp to cast shadows in the corners of the room and along the walls . . . with all that gold aboard and so close to the coast, where perhaps a fleet of Junks was waiting to come sweeping out for the grand attempt just outside of one of those many secluded coves. Yes, the China Coast is mysterious in many ways. And many strange things have happened along there.

Eddie Miller needs no further introduction to the Air Corps Advanced Flying School at Stockton, California, having
(Continued on Page Seventeen)

Somewhere EAST of SUEZ..

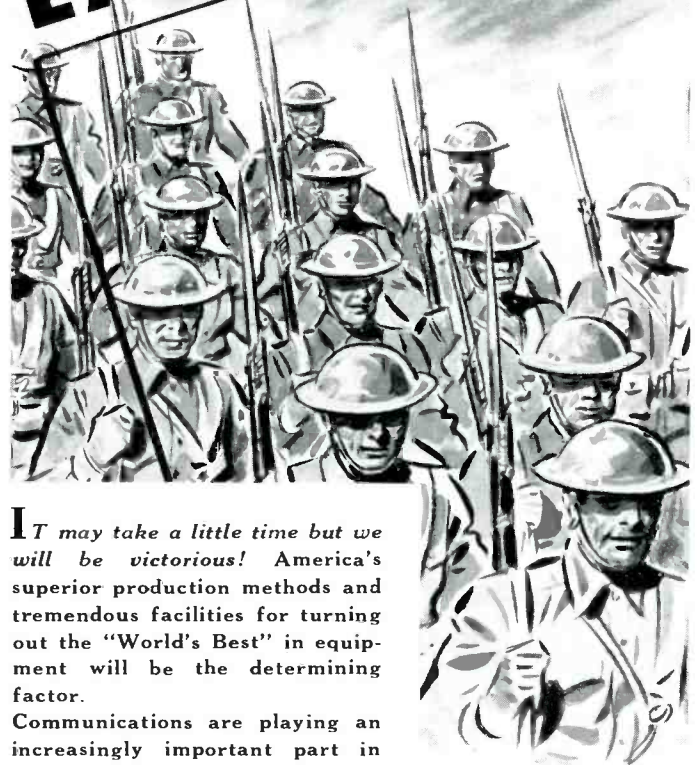

IT may take a little time but we will be victorious! America's superior production methods and tremendous facilities for turning out the "World's Best" in equipment will be the determining factor.

Communications are playing an increasingly important part in our National Defense on land, at sea and in the air. We are justly proud that we have a hand in creating communications equipment for our country.

Model S-27 (Illustrated) FM-AM reception. 15 tubes. 3 bands. 28 to 145 mc. \$195.00. Model S-27B. 38 to 165 mc. \$195.00.



the hallicrafters co.
CHICAGO, U. S. A.

Keep Communications Open!

San Francisco News

By Frank Barron

NOW it can be told: Joe Baker, Ch. Engr., KPO, and Art Dingle, T.E. KPO, practically scored a scoop on the world on the Pearl Harbor incident. While tuning for a time tick to check the station clock on that fateful Sunday, they were amazed to hear NPM giving the "ALERT" and talking about Jap planes being overhead. As this was considerably in advance of any flash on the network, imagine their consternation.

Due to network split and the attendant shifting of personnel we welcome three new members to the Studio Staff at San Francisco—Clarence T. Stevens, formerly of KSFO; R. C. Butler, ex-KLS, Oakland, and Hal J. Ashby, formerly of Telephone Equipment & Repair Company, operators of extensive public address systems. Good men, all three. Welcome to N.A.B.E.T.

Clark Sanders emphatically denying he is blue because he is BLUE.

George McElwain now occupying Field Supervisors desk chair. Congratulations from the gang, Mac.

Beverly Palmer, former CR Supvr., will be absent and greatly missed from N.A.B.E.T. dinner-meetings on account of his well deserved promotion to Engineer-in-Charge of BLUE, at San Francisco. His infectious laugh and ready wit proved the high spot of many a meeting. Congratulations to you, Bev.

Cliff Rothery, S.E., complaining he is not getting enough volunteer diggers to help him out on his extensive gardening; what with the all-night watch weakening his

stamina for daytime labor. Better change the brand of the bait, Cliff.

Tommy (Senator) Watson, S.E., stepped out of the Manx Hotel entrance the other day wearing his famous five-gallon hat. Was immediately approached by a high ranking uniformed military official asking "how many



"Due to circumstances beyond our control, the program originally scheduled for this time — will not be heard!"

thousand head he could deliver on the hoof, and F.O.B. where?"

Danny Williams, F.E., doing a bang up job running the Jack Benny show out at the Presidio, and then having the Los Angeles announcer on the closing cut-in sign off with "This program came to you from Hollywood."

Guy Cassidy still trying to outwit the priority board on material for the new house he is building, and getting away with it, too.

Jim Summers, CR Supvr., suffering a bad three days when his pedigreed pup escaped from home and went on a lark. Pup recovered in the city pound later for the usual three bucks. Recently married, Jim now knows the anguish a mother can suffer over the loss of her offspring.

Harold Platt, S.E., formerly of Reno, has taken possession of a brand new little home down the Peninsula. Likes to dig in the San Carlos dirt just for fun, after having to blast for a garden in the rocks around Reno.

From the questions Andy Mitchell, Rcdg Engr, has been asking me lately, I wouldn't be surprised if I were to meet Andy on the Commuters Special from down the Peninsula some day. How about it, Andy?

Ed Manning, T.E. KPO, coaxing the most out of his tires on account of the rubber shortage. Ed says they got to last even though Communication employees do rate about two-thirds down from the top on the priorities list for re-caps.

Mort Brewer, T.E. KPO, wondering if the submarine net will hold the big ones (striped bass) outside the Gate.

The bachelor ranks are shrinking fast. Harry Jacobs,

(Continued on Page Sixteen)

A NEW STORE for BETTER SERVICE

Yes, for better service to our patrons we have opened a new store at 85 Cortlandt Street. Here we have consolidated our great stock of essential radio parts and equipment. Now you are assured the best possible service and most speedy delivery of your orders under present conditions.

TERMINAL RADIO CORP.
85 CORTLANDT STREET
« NEW YORK CITY »
TELEPHONE WORTH 2-4416

Transmission Line Coupling

(Continued from Page Nine)

curves. These curves were obtained with resistance loads substituted for the receiver inputs.

The coupling and switching system can be built as a unit, all filter sections, switches, coupling tubes and 500-72 ohm output networks being included. Switching may be done manually or by remotely operated relays. The latter is preferable, as switching may be done from the receiver positions. Such a unit is shown in the accompanying photograph (Fig. 4). It is advantageous to keep to a minimum the capacity to ground of all wiring carrying RF. As one unit, the inputs are transmission lines, and the outputs are coaxial lines to the receivers.

An extra input circuit and set of relays may be added, this circuit being fed from a calibrated oscillator for setting the receivers to a given frequency.

The power supply for the tubes is a separate unit. If rectified AC, it should have very low hum content. The power supply filter should be at least two sections with the capacitors being 125 mfd. each.

In all the diagrams capacitors are shown in shunt with the RF filter coils. In this particular case, the distributed capacity of the coils is sufficient, so no capacitors need be connected. For this reason no values of capacity are shown.

In the event 6AC7 (1852) tubes are not available, the 6SH7 may be used. The gain will be lowered about 40 percent. To obtain the proper operating characteristic the cathode and screen resistors will have to be less than the values for the 6AC7. For the 6SH7 the cathode resistor will be about 75 ohms and the screen resistor from 22,000 to 25,000 ohms. These values are on the basis of a 250 volt power supply.

The photo, Fig.4, shows a transmission line coupling unit of the type shown in Fig. 2 under construction. Provision is being made to accommodate three transmission lines, signal generator for calibration purposes, and ten receivers. The terminals for the transmission lines are shown on the left side adjacent to

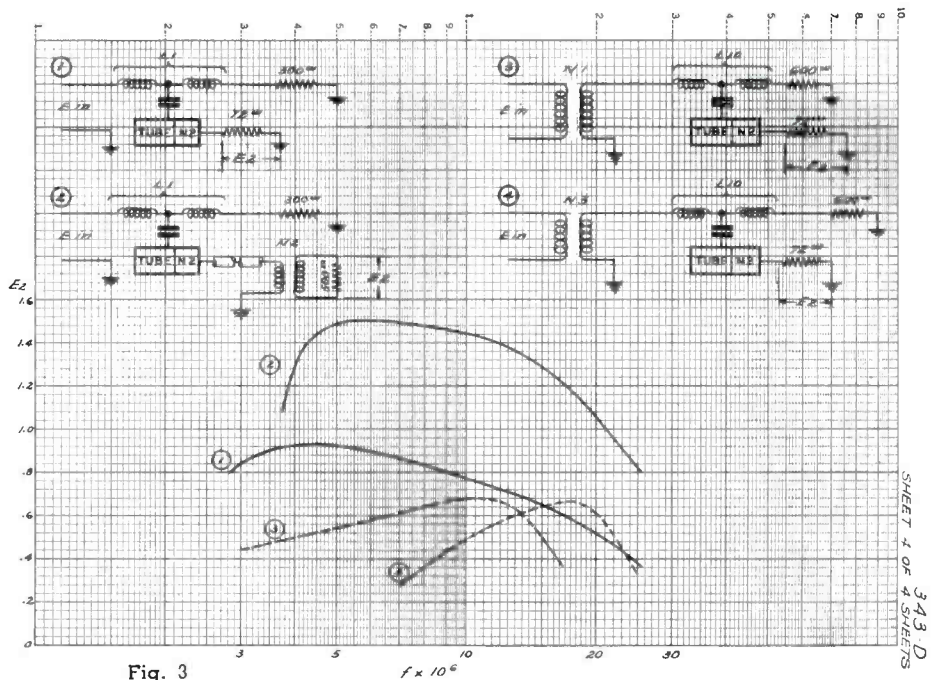

Fig. 3

the first three horizontal rows of relays. The filter sections progress to the right and may be seen under the relays. Accommodation for ten receivers is pro-

vided by having five filter sections on each side of the transmission line. The fourth horizontal row of relays is fed

(Continued on Page Sixteen)

Bliley

ACCURATE **DEPENDABLE**

Catalog G-12 describes Bliley Quartz Crystal Units for frequencies from 20 kc. to 30 mc. Write for your copy.

QUARTZ CRYSTALS

FOR GENERAL COMMUNICATION FREQUENCIES

BLILEY ELECTRIC COMPANY
 UNION STATION BUILDING ERIE, PA.

TECHNICAL PRESS REVIEW

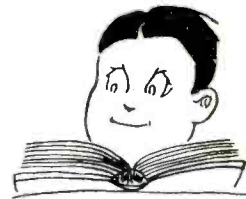

A digest of leading technical articles in the current contemporary press.

Compiled by: TOM GOOTEE

[In these busy times few engineers can spare the time required to read all the current technical literature. It will be the purpose of this regular feature to provide an index of current technical articles on radio broadcasting and related subjects.—Ed.]

PROCEEDINGS OF THE I.R.E.

(February, 1942)

A New Air-Cooled 5 KW Transmitter

By F. W. Fischer

A new Westinghouse 5-kw broadcast transmitter, placed on the market last fall, is described in this article. The arrangement of the various components in each cubicle is shown by numerous illustrations. One method of adapting a single blower to the cooling needs of the entire transmitter is explained, as are the interlocking and switching relays of the equipment. A fundamental schematic, without circuit values, is also given.

A Stabilized F-M System

By Roger J. Pierucci

A wide-band F-M system for commercial broadcasting is described, in which the center frequency is directly con-

trolled by a single quartz crystal—with a resulting high frequency stability. A system of distortion correction in a phase modulator is also considered, in which the maximum angle of phase shift may be 60 degrees or more with low attendant distortion; accomplished by modulation of both the carrier and the sidebands.

Sources of Spurious Radiations in the Field of Two Strong Signals

By A. James Abel

An investigation has been undertaken into the source of combination, or spurious, signals in the field of two strong broadcast signals. It is shown that these interfering signals are the result of non-linearities in the antennas of the receiving sets tuned to one or the other of the initial broadcast signals. Suggestions for reducing this type of interference are considered only briefly—it being the main purpose of this article to discuss the theoretical aspects of this phenomenon.

Frequency Converters for Superheterodyne Receivers

B. E. W. Herold

This is a highly technical treatment of the operation of frequency converters and mixers in superheterodyne circuits, and is of interest principally to receiver design engineers.

Performance of Electron-Guns in Television Cathode-Ray Tubes

By R. R. Law

Using Langmuir's formula for the limiting-current-density relationship (for determining the performance of the electron-gun in cathode-ray television tubes) as a basis, the author presents a more simple, easily expressed relationship correlating the various important factors governing electron-gun performance.

ELECTRONICS

(February, 1942)

Automatic Record Changes

A Survey — By Craig Walsh

An excellent general survey of all principal types of commercial automatic record changers and record manipulators has been prepared by the editors of Electronics. Following a semi-technical discussion of the basic principals of current types of record changers, a commentary is given on

ATTENTION!

We have been appointed
distributors for

CANNON EQUIPMENT

A complete stock is carried at
all times

We have the largest stock of short
wave parts in the country

Send us an order for trial

Send for complete catalogue

Newark Electric Co.
323 WEST MADISON STREET
CHICAGO, ILL.

several types of the most popular changers—from both the technical and practical standpoint. Among the types discussed: The R.C.A., the Garrard, the General Instrument, and the Farnsworth.

Electronic Detection System

A Survey — By W. W. MacDonald

Not of a broadcast or television nature, but meriting mention is this editorial survey concerning Burglar-Alarm devices and other modified forms of so-called "Electronic Intrusion-Detection" systems. A number of commercial



Photo by DE SOMOV

"CORNERED"

An NBC - NY Radio City patrolman stops Engineer Sturgell for identification!

systems are discussed, together with several fundamental circuits explaining the electronic operation of these safety and protective devices.

Skin Effect Formulas

By J. R. Whinnery

This is a compilation of working formulas (and associate graphs) for the determination of skin-effect resistance—particularly at the *higher* frequencies. The article contains excellent reference material, originally prepared and used by the General Electric Company. This is a practical equational treatment of the subject, *without* a complete theoretical analysis of skin-effect. From the given formulas, the skin-effect resistance (in ohms) can be more accurately determined for the following conditions: A *plane solid* of infinite depth; *round wire* at low frequencies, at very high frequencies, or at any frequency; *tubular conductors* at very low frequencies, at very high frequencies, or at any frequency; *conductors* coated with *other* conductors; *conductors* coated with a thin layer of poor conductor or imperfect dielectric.

A Simple Carrier-Current Communicator

By James L. Smith

This device, described in much practical detail, makes possible the use of a single telephone pair to carry two separate and independent carriers. Originally, a police transmitting and receiving site remote from the control point made it necessary to use two pair of wires: one to feed audio to the transmitter for broadcast, the other to feed received signals back to the control point. But by the use of the carrier-current device described in this article, it was possible to use only *one* pair of wires to feed audio programs in *both* directions at the same time. Its remarkable simplicity makes this circuit very practical for broadcast or other radio work, where only one pair of line-wires is available—and more than one signal carrier must be maintained.

COMMUNICATIONS

(February, 1942)

F-M Vital to Communications

By Herbert Du Val, Jr.

A recently completed series of tests to determine the comparative practicability of F-M equipment for both fixed and mobile communication (up to about five or six hundred miles) yielded some interesting results, which are set forth in this article. While the General Electric F-M equipment (operating on the 40 mc channels) was designed and tested

(Continued on Page Seventeen)

CAPPS*

SAPPHIRE is, and has always been, the only material for making cutting styli for high class recordings.

CAPPS* Patented Sapphire Styli are the original and accepted standard for high class professional acetate recordings.

Imitated but not equalled

FRANK L. CAPPS

244 W. 49th STREET NEW YORK CITY

Telephone Circle 6-5285

*Reg. U. S. Pat. Off.

Transmission Line Coupling

(Continued from Page Thirteen)

from the calibrating signal generator. The relay outputs are paralleled vertically, each vertical row connecting to the input of a coupling tube. The row of coupling tube sockets may be seen just above the output coupling coils, which in turn tie to the receiver transmission lines through the shielded connecting block at the lower left. The terminal strip at the lower right is for power leads and relay operating circuits.

This system is flexible in its operation, accomplishing the results previously outlined. Its use should benefit materially the operation of installations similar to the hypothetical case previously stated.

The author expresses appreciation to Mr. R. E. Shelby, Development Engi-

neer, and Mr. E. D. Goodale of the Development Group for their assistance in connection with the development of this unit. The straight-forward mechanical design was by Mr. W. C. Resides of the Audio Facilities Group, under the direction of Mr. C. A. Rackey, Audio Facilities Engineer.

DIATHERMY

(Continued from Page Five)

physio-therapy units may be quickly changed to highly efficient radio transmitters—with powers in the neighborhood of 200 watts. With only a little manipulation, these machines can be tuned to almost any wave-length. But most effective daylight channel has been found to be about 20 megacycles; at night the 7 megacycle band is most widely used.

The number of these illicitly-operated machines in the hands of enemy agents is not known. The machines can be

purchased fairly easily, and require no licensing of any kind. In spite of the war—and the possibilities of the use of such machines in this illegal manner—diathermy units can still be bought on the open market. Purchasers are being checked by the FBI—as far as possible—but this leaves a great many machines unaccounted for. And here is the chance for any ex-ham or average listener to do radio and his country a real service!

The reception of any suspicious signals of any nature should be reported either to your local Federal Bureau of Investigation or the nearest office of the Federal Communications Commission—giving as much information as possible concerning the signals you heard: the approximate frequency, time of day heard, character of signals, intelligibility of signals, and any other information you can accurately discern.

It's going to take the concerted effort of everyone to win this war!—T. E. G.

San Francisco News

(Continued from Page Twelve)

S.E., took the step on March first and can now join the control-room home economics discussions as a fully qualified expert. A notable event of the wedding is a full length

16mm colored movie film of the entire ceremony. How many of us wish we could boast of a similar valuable keepsake. Photography was in the expert hands of G. W. Andresen, S.E.

Mark Dunnigan, S.E. back on the job after an illness. Thinks he will get his kitchen painted after all, if he can only get some good paint.

Ken Owens, former S.E., has joined the staff of Pan American Airways as construction engineer. His destination is Africa, and he is on his way. Our stamp collectors are waiting for his first post-card.

J. Allen O'Neil now rates the title of Recording Supervisor. J. Allen's only worry on the rubber shortage is for rubber cement for labeling, as he doesn't like cars anyway.

We extend our condolences to J. R. McDonnell, S.E., on the recent loss of his father.

E. E. Jefferson, CR Supvr, not taking chances on fuel oil rationing. He has a most utilitarian pastime. Cuts firewood for his fireplace from the Sutro Forest right at his backyard, and the woodpile is assuming large proportions. Sutro Forest is literally catching "blazes."

Three men from KPO, Joe Baker, Mort Brewer, and Bob Barnes, are taking the National Defense Communications course at Stanford University.

Henry Dunton, T.E. KGO, overhauling his fishing gear and hopes for a record year.

Dick Parks, T.E. KGO, recently a part-time bachelor while wife South on a visit.

George Dewing, S.E., has a remarkable view of the ocean from his house windows, and fills in for the boys in control room on what goes on outside the Gate. The view from CR only takes in the inner harbor. Boy, are we going to miss that swell view soon when we move to the house with no windows.

Jack Irwin, T.E. KGO, goes in for model railroading

CANNON PLUGS and RECEPTACLES Now Stocked in New York

We have been appointed distributors of Cannon sound plugs and receptacles and now carry a complete stock of this equipment.

The Cannon Electric Development Company, Los Angeles, Cal., wishes to assure fulfillment of their customers' requirements in these uncertain times. Here is additional evidence of Terminal's record of regular and reliable delivery of essential radio materials in the face of trying conditions.

TERMINAL RADIO CORP.
85 CORTLANDT STREET
« NEW YORK CITY »
TELEPHONE WORTH 2-4116

in a big way. Understand Jack has quite a layout, and builds all the equipment himself.

Have you been wondering what some of the former hams are doing now that the lid has been on. Well, Jimmie Ball just leaves off the R.F. and goes in for high class high fidelity amplifiers.

Technical Press

(Continued from Page Fifteen)

for state police radio work—the results are none the less interesting to broadcast and general communication engineers. Most notable of the results tabulated was the overwhelming superiority of F-M over A-M in performance (for radio work of this nature), and the more efficient operation of this F-M equipment as opposed to similar A-M apparatus (less power drawn from source, fewer tubes in F-M, and less maintenance required).

Coastal Radio-Telephone Systems

B. H. M. Pruden

Old-timers in coastal and ship-to-shore radio will marvel at the newly developed coastal control equipment described in this article. Devoted exclusively to a general discussion of the audio and relay control apparatus, several new innovations (developed by the Bell Labs.) are explained in some detail: Selective signalling systems (frequency dialing), busy-signal controls (indicating a channel in use by another ship), and complete (almost automatic) operation of the radio transmitters.

Emergency Communication Nets

By S. Gordon Taylor

The rehabilitation of otherwise-silent amateur radio equipment as new and vital links in this country's Emergency Communication Network is described in this article. Important ramifications of this new operating plan are considered, and much information is presented for the amateur interested in this important field of war endeavor. Recommended reading for all radio amateurs!

Hollywood

(Continued from Page Eleven)

ing just recently engineered the Chase & Sanborn show from there. Eddie is one of our topnotch Hollywood engineers. Even has a top-notch moustache.

For the Flying School show, Eddie gathered together a portable booth, equipment, gassed up his car and from there on in the show is a matter of record the air-lanes. Eddie says it was a swell experience.

Art Brearley, engineer for Red Skelton and the Flagg and Quirt shows, announced the arrival of a Bundle for Brearleys the other day with the following report:—

Engineering Department,
Alterations Report.

Re.—The Brearley Circuit.

On February 6 of this year, at 8:18 A. M., a 1942

model streamline "Grid Leak" was installed in the Art Brearley Circuit.

The addition of this newly-designed and most advanced article should result in almost continuous operation—with fewer idle hours.

The main duties hitherto performed by the two principal components of this standard circuit will in the future



differ in many respects. Instead of providing the bias one for another—as in the past—all the output of both these essential elements will be consumed and promptly dissipated by this new addition to the circuit. Whatever energy may remain may, for all practical purposes, be considered as nil.

Essential data and information: — Capacity, 7 lbs., 7½ oz.; dimensions,

length 20½, circumference 14; color code, brunette with blue eyes; type, definitely male.

Designer's notes: Have observed all characteristics carefully and so far, after fourteen days and nights of continuous operation, have come to the conclusion that the best results may be gained from this little model if used in connection with the announcing department rather than the engineering field.

P. S.: Am thinking very seriously of offering his services in the promotion of the "Blue," in which Mr. Swallow of the West Coast feels definitely he has a place.

CONTROL APPARATUS by AUTOMATIC ELECTRIC

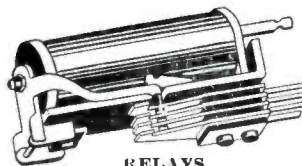

RELAYS

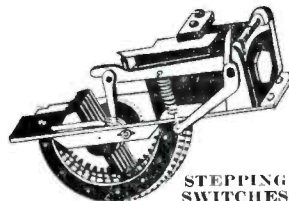

STEPPING SWITCHES

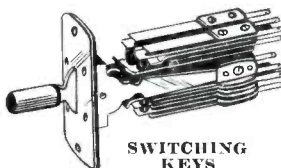

SWITCHING KEYS

IN AMERICA'S leading radio broadcast studios, Automatic Electric remote control devices are used for the dependable operation of such important equipment as master control boards and announcers' cabinets, for program monitoring and switching, and for other electrical control uses.

These devices have a built-in quality that is the direct result of over 50 years experience in the design and manufacture of communication, signaling, and control systems, utilizing the same engineering skill that revolutionized telephony with the automatic dial telephone.

A complete engineering and consulting service is available to broadcasting studios on any electrical control problem. Avail yourself of this service today by writing—

American Automatic Electric
Sales Company

1033 West Van Buren Street
Chicago, Ill.

AUTOMATIC ELECTRIC

TELEPHONE, COMMUNICATION, AND SIGNALLING EQUIPMENT

RIDING GAIN

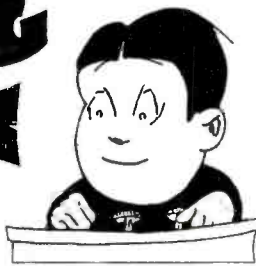

ON THE AIRALTO WITH FONGOOTEE

ONE way to get into radio is to grow up in the business. That's what Don McNeill did, and today he supervises the festivities of that very successful early morning show: the *Breakfast Club*. It all started back in 1928 when Don stepped out of Marquette University and obtained his first job with a Milwaukee, Wisconsin, radio station at \$10 per week; the job involved acting as announcer, radio editor of the associate newspaper, riding gain in the control room, directing radio acts, rounding-up talent, playing records, and sweeping out the studio at night—and he also answered telephones. In 1930 he hopped southward to Louisville, Kentucky, where he was 50 per cent of a radio comedy team known as the Two Professors. Three years later, McNeill headed for Chicago as an NBC announcer—only to be slated for a staff comedian-emcee before he could hang up his hat. He and the *Breakfast Club* began simultaneously; and during the years since he has amassed an audience of loyal fans who get out of bed at unholy hours to hear him cavort on the airlines.

Harold Peary, the *Great Gildersleeve*, has published a book—ghost-written by his fans. The book is a compilation of recipes sent in by his radio listeners, who know about his avid hobby.

* * *

It costs \$40 to ride a taxi from New York to Boston—according to Ann Thomas, who plays the part of “Lilly,” the whacky maid on CBS’ *Meet Mr. Meek* series. It all came about when Ann’s beau, a young Naval Lieutenant, came down from Boston to see her in New York. Due back in Boston harbor early the next morning, he missed the last train, couldn’t hire a plane because of bad weather—and took the next best transportation: a taxicab. Ann went along for the ride—a round trip of only 500 miles.

* * *

Eddie and Fanny Cavanaugh can claim the distinction of being the oldest radio team in the middle-west. Twenty years ago this month—in March of 1922—they made their radio debut as a song team over KYW, and have since been heard over practically every station in Chicago.

* * *

And speaking of the old-timers of radio, there’s no sighing for the “good old days” among broadcasting’s veterans. These are the halcyon times for most of the kids who started out in the business back in the days of crystals, wet batteries, and regenerative circuits. They get as much for one show now as they used to get for thirty or forty shows a week “way back when.”

* * *

At least five California women drivers had sweet revenge on Ransom Sherman for the burlesque satire he aired on the inefficiency of feminine steering—when the comedian checked into the California Motor Vehicle Department to trade his visitor’s permit for a state driver’s license. “Ransom Sherman?” queried the first clerk to whom Sherman made application. “Oh, yes! I heard you on the air last Friday night.” Following which, the first girl and four cohorts proceeded to shuffle Sherman back and forth for four hours, filling out long and unnecessary applications and taking various tests—before he finally obtained his license.

* * *

Dinah Shore is running up some kind of a record for decorations, awards and “crowns.” She was voted “The Girl We Wish Would Come to Dinner” by the annual New York Butlers Ball. Hair-dressers in convention nominated her the “Girl with the Loveliest Hands.” All of which was topped off by a Tennessee Chamber of Commerce order crowning her the “Hostess-in-Chief of the Chattanooga Choo Choo.”

* * *

And speaking of records—and Chattanooga—over 1,300,000 phonograph records have been sold of Glenn Miller’s waxing of the “Chattanooga Choo Choo.”

PATERSON: 79 Bridge Street	NEW BRUNSWICK: 54 Albany Street
AARON LIPPMAN & CO.	
246 Central Avenue	Newark, N. J.
Leading Radio Equipment Distributor of New Jersey Prompt Service at No Extra Cost	

Courmettes & Gaul
OPTICIANS
55 West 49th Street R. C. A. Building, New York Main Floor
EYE EXAMINATIONS
Prescriptions Filled . . . Prompt Repair Work

Ham and eggs aren't usually associated with the kind of personality identified by a name like Yvette, yet that good ole American dish is a favorite of the songstress with Mmmmmmm! in her voice. It was just two years ago that 19-year-old Elsa Harris, of Birmingham, Alabama, was signed to her first radio contract—with NBC—which not only changed her name, but started her on a meteoric and successful singing career.



* * *

Henry Gauthier, the sound-effects expert for the *Are You a Missing Heir* show, is acquiring something of a mortician's complex. Henry says he has the depressing role in every broadcast. When the heirs turn up to be joyous and collect manna from heaven—they provide their own exultant sound-effects. But when the show dramatizes the passing of the bequeather, Henry goes to work. His trickiest stunt: the sound effect for a man stumbling into a river and drowning.

* * *

Ralph Edwards, the *Truth and Consequences* head man, isn't easily startled by weird consequence suggestions sent in by fans—but he received one recently which almost floored him. The contributor suggested that Edwards hire the U. S. Senate Chambers for a few minutes—and have the unlucky contestant conduct a filibuster!

* * *

Since Jay Jostyn assumed the title role of *Mr. District Attorney* of the air, about two years ago, he's been the recipient of gifts and mementoes from listeners ranging from ancient firearms to sets of law books. But a unique

★ ★ WE CAN HELP YOU ★ ★

KEEP ON THE AIR

Broadcast stations today must be prepared for any and all emergencies. If replacement or maintenance parts are difficult to obtain in view of present production restrictions and allotments, let SUN help you with your problems.

★

WE HAVE THOUSANDS and THOUSANDS of RADIO PARTS

AVAILABLE for INSTANT DELIVERY!

★

Complete Broadcast Equipment

TUBES • METERS • CONDENSERS
RESISTORS • SWITCHES • TRANSFORMERS
RELAYS • WIRE • INSULATORS
SOCKETS • PANELS, ETC.

All Nationally Advertised Products in Stock!
NEW YORK'S OLDEST RADIO SUPPLY HOUSE

Telephone: BArelay 7-1810

Est.
1922

Try
SUN
Service

gift was recently delivered to him from a fan in Chicago; opening a rather hefty parcel, Jostyn found a bullet-proof vest!

* * *

Walter Tetley, who plays the nephew on NBC's *Great Gildersleeve* program, has nabbed a coveted role in the movie based on the life of Lou Gehrig: "Pride of the Yankees." He'll take the part of a tough Irish kid, boyhood chum of Gehrig.

Cleveland News

By J. D. Disbrow

EVERYONE is becoming very First Aid conscious out this way. Two of the members of the Engineering Staff have completed their courses in First Aid at the Red Cross Headquarters and are now qualified instructors. Each week a first aid class is held both at the transmitter and at the studios. Mr. Hackett is the studio instructor and Mr. Stewart is the instructor at the transmitter. The attendance has been nearly 100 per cent at every class and the members are receiving a very complete course in all phases of First Aid. Little did we realize four years ago, when these new studios were beng built, that we were setting up our Main Equipment Room in a very substantial bomb-proof room. The building was a former bank building and the main vault, which has twenty inches of steel and concrete as well as a five-eighths inch steel lining, was selected for the Main Equipment Room adjacent to Main Control. In the rear of the main vault a second vault is

located which is treated in the same manner. These spaces have been arranged, and the necessary emergency equipment moved in, for future use in case of air raids.

Local colleges are starting classes in Radio instruction for selectees and others who feel they can be of service to their country in the radio end. Mr. F. C. Everett was one of the first to be selected from the broadcasting stations as an instructor at Fenn College. It is expected that others will be selected in the near future as classes are formed.

Authorization has finally been granted for the removal of two sections from the vertical tower and work is under way to complete this job. The main idea is to reduce the sky wave which has been created since the change in frequency some time ago. It is expected we will have to work on the emergency antenna for about a week.

Should any of our readers notice changes in reception of WTAM we would be pleased to hear from you.

Our Own Quiz Program

By Tom Gootee

WITH all the different Radio Quiz programs on the air these days, almost everyone is Question-and-Answer conscious. The time now seems ripe—or over-ripe—to launch our own Radio Operating Quiz Program!

And suiting the action to the purpose, we submit the first of our amazing Questions. You select the proper answers from those given below. Let your conscience be your guide—and will you be surprised at the results.

Try some of these on your friends. To tally your score: add up all your answers, multiply by the square root of 3, and then subtract your telephone number. The one with the biggest score is probably the biggest liar.

1. When a vacuum tube in operation becomes very hot and emits a red light and flame, it is a sign that (1) You are probably color-blind. (2) You should raise the plate voltage on the tube. (3) An apple a day keeps the FCC inspector away.

2. When you get as many as eight or nine stations at once on your home receiver, it is a sign that (1) Your radio has a good pick-up. (2) Your antenna is probably grounded to a sewer pipe. (3) You are probably plastered.

3. When the Telephone Company reports several two-minute cuts during your network commercial, you reply (1) "Oh, that was part of the sound effects!" (2) "It must have been the announcer's error!" (3) "It's OK leaving here; trouble must have been west of Denver!"

4. When the needle of your Volume Indicator suddenly wraps itself around the +10 peg, it is a good sign that (1) You must have some feedback from New York or Washington. (2) The stock market is due to drop. (3) Somebody hit you when you weren't looking.

5. When a very attractive young actress asks you later "if she really sounded good during the broadcast," you



Photo by James Shultz of WCAE

The Devil's Choir, or—The Four Over-ripe Barrymores! Left to right are Ray Guy of NBC, Paul Loyette of WHO, Dr. W. L. Everett of Ohio State University, and Lynne Smeby, President of NAB, in a skit presented at the banquet for the amusement of the Fifth Annual Broadcast Engineering Conference.

should always reply (1) "Oh, you sounded fine, Miss Blotz." (2) "Well, you *could* stand some more coaching; now what are you doing tonight?" (3) "Baby, confidentially, you ———!"

6. The three chief attributes of a good radio engineer are that he be (1) Deaf, dumb and blind. (2) Dumb, blind and deaf. (3) Blind, deaf and dumb.

7. A vernier control is (1) A venetian blind. (2) A plan of crop rotation on farms. (3) The difference between your 1940 gross income and your 1940 net income.

8. A fader is (1) A gadget for making home brew. (2) Two jiggers of gin in a quart of gingerale. (3) A seaport in Southern Russia.

9. A script is (1) A dance done in burlesque. (2) A corn remover. (3) Where elephants go when they die.

10. A Master Control Room is (1) A place of hibernation for ferocious beasts. (2) The shortest distance between two moving points. (3) Where you told your wife you were the night you went out with some of the boys.



See what I mean? — Ed.



Courtesy TIME

“...so he whispers: ‘QUIET—WE’RE ON THE AIR!’”

“Give me a big-league program at a sandlot price,” says Burdick grimly, “and maybe I’ll talk about radio.” That’s his slant when we start the annual budget battle. And he figures it closes the issue. But he doesn’t know about the ace we have up our sleeve.

“You see, we agencies with limited facilities have to stay on our toes. We’d looked into NBC Radio-Recording a long time ago... found out that they’re ready to work with you on anything from a series of simple announcements to a full-length script show... they’ll write, cast, produce and record your pro-

gram from Hello to Goodnight... Yes, and after it’s recorded, handle the manufacture and distribution of your records, too!

“Well, I’m telling you—the job they turn out for us is a honey. We get the old man over to hear it. As he listens, he keeps getting madder and madder—’til finally he jumps up and shouts: ‘What are you trying to high-pressure me into? I’d have to go in hock to sponsor a show as hot as this one!’

“So, when I tell him how little it will actually cost him, he can’t believe his ears. So I tell him again... a little *louder*. As it sinks in, a smile

spreads over his face and he whispers: ‘Quiet—we’re on the air.’”

• • •

Whatever the program problem you’re working on, why not make use of the professional services available at “Broadcasting Headquarters”? No matter how large or how small it may be, our 47 master showmen are ready to work with you... from script to finished pressing. And what’s more, we record your show NBC ORTHACOUSTIC, which means reproduction at its best.

Let’s team up—write or telephone today and outline your problem.



NBC Radio-Recording Division

NATIONAL BROADCASTING COMPANY

A Radio Corporation of America Service

RCA Bldg., Radio City, New York • Merchandise Mart, Chicago • Trans-Lux Bldg., Washington, D. C. • Sunset and Vine, Hollywood



The Navy says:

"WELL DONE!"

...and Radio Research Contributed

The Navy "E" pennant, symbol of achievement in war production, is the highest praise the United States Navy can bestow on an industry.

▶ Recently awarded to RCA Manufacturing Company, this emblem of excellence is a tribute to the loyalty and cooperation of the men and women who are working night and day to "Beat the Promise" to the Government on delivery dates of vital war equipment.

▶ It is a tribute, also, to RCA radio research which has helped in large measure to make America's naval

and military radio equipment the finest in the world.

▶ When the war is won, many of these wartime applications will serve industry, and the public, by helping to create new services and products. Today, at Princeton, N. J., the new RCA Laboratories building is taking shape—destined to be the world's foremost center of radio research. Surrounded by every modern tool of research, workers in the new Laboratories will continue to seek new knowledge of radio and electronics... new discoveries for America at war and America at peace.

RCA LABORATORIES

A Service of the Radio Corporation of America

Other RCA Services:

RCA Manufacturing Company, Inc. • R.C.A. Communications, Inc. • Blue Network Company, Inc.
National Broadcasting Company, Inc. • Radiomarine Corporation of America • RCA Institutes, Inc.